

The Cedar | Plan G012 | First Floor
2,986 sq. ft. | 4 Bed | 2.5 Bath | 3 Car Garage | 2 Story

FLEX LIVING OPTIONS: Bay Window. Fireplace. Study. Gourmet Kitchen. Sliding Door. Covered Outdoor Living.

REV 17-012
The Oaks of Southglen
G012

Any floorplan and/or elevation rendering is an artist's conceptual rendering intended to provide a general overview, but any such rendering does not constitute actual plans and specifications for any home. Renderings and pictures are representative and may depict floorplans, elevations, options, upgrades, landscaping, and other features and amenities that are not included as part of all homes and/or may not be available for all lots and/or in all communities. Renderings may not be drawn to scale. Any provided dimensions are approximate and actual dimensions may vary. Homes may be constructed with a floorplan that is the reverse of the floorplan rendering. Plans are copyrighted and/or otherwise subject to intellectual property rights of Meritage and/or others and cannot be reproduced or copied without Meritage's prior written consent. Plans and specifications, home features, and community information are subject to change, and homes to prior sale, at any time without notice or obligation. Additionally, deviations and variations may exist in any constructed home, including, without limitation: (i) substitution of materials and equipment of substantially equal or better quality; (ii) minor style, lot orientation, and color changes; (iii) minor variances in square footage and in room and space dimensions, and in window, door, utility outlet, and other improvement locations; (iv) changes as may be required by any state, federal, county, or local governmental authority in order to accommodate requested selections and/or options; and (v) value engineering and field changes.

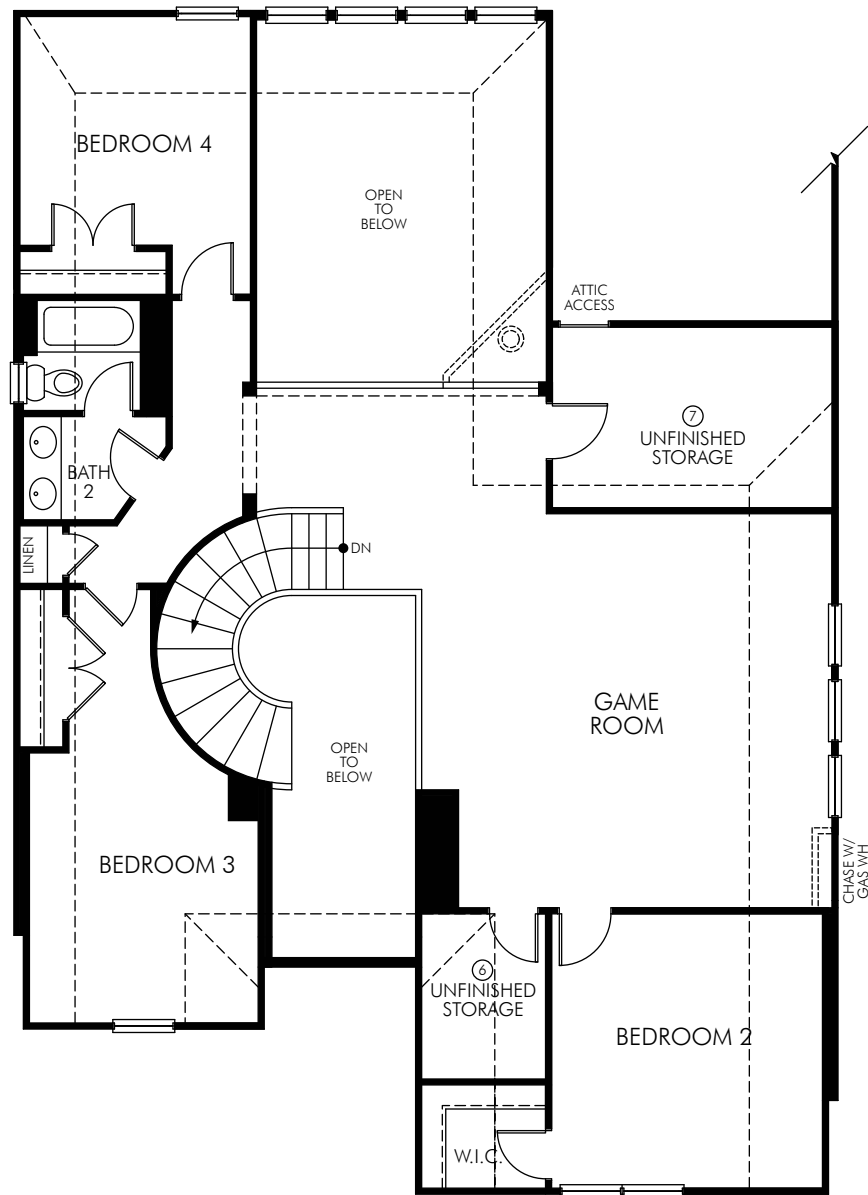

The Cedar | Plan G012 | Second Floor
2,986 sq. ft. | 4 Bed | 2.5 Bath | 3 Car Garage | 2 Story

FLEX LIVING OPTIONS: Bath 3. Media Room.

Any floorplan and/or elevation rendering is an artist's conceptual rendering intended to provide a general overview, but any such rendering does not constitute actual plans and specifications for any home. Renderings and pictures are representative and may depict floorplans, elevations, options, upgrades, landscaping, and other features and amenities that are not included as part of all homes and/or may not be available for all lots and/or in all communities. Renderings may not be drawn to scale. Any provided dimensions are approximate and actual dimensions may vary. Homes may be constructed with a floorplan that is the reverse of the floorplan rendering. Plans are copyrighted and/or otherwise subject to intellectual property rights of Meritage and/or others and cannot be reproduced or copied without Meritage's prior written consent. Plans and specifications, home features, and community information are subject to change, and homes to prior sale, at any time without notice or obligation. Additionally, deviations and variations may exist in any constructed home, including, without limitation: (i) substitution of materials and equipment of substantially equal or better quality; (ii) minor style, lot orientation, and color changes; (iii) minor variances in square footage and in room and space dimensions, and in window, door, utility outlet, and other improvement locations; (iv) changes as may be required by any state, federal, county, or local governmental authority in order to accommodate requested selections and/or options; and (v) value engineering and field changes.

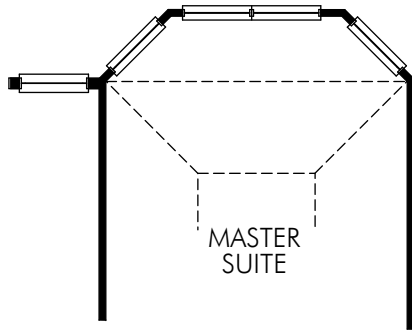

① OPT. MASTER BAY
BAY0005

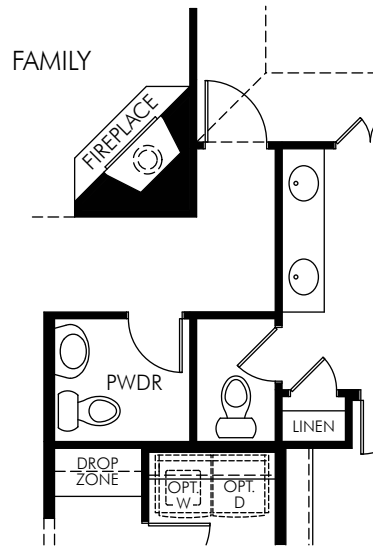

② OPT. FIREPLACE
FPO108

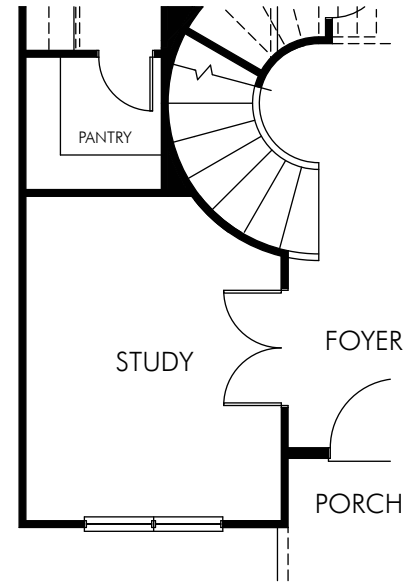

③ OPT. STUDY
RMO0015
WINDOW CONFIGURATION
VARIES PER ELEVATION

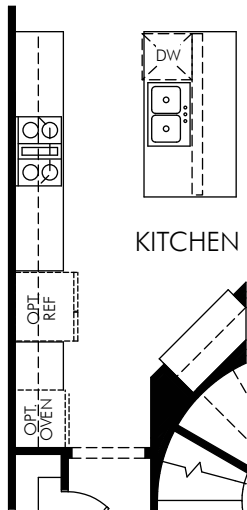

④ OPT. GOURMET KITCHEN
KIT000

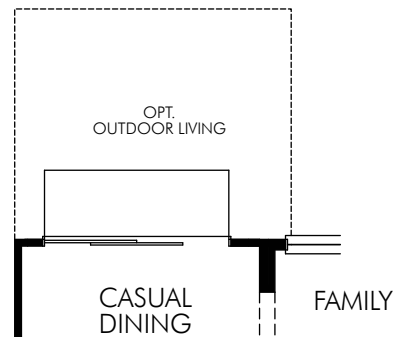

⑤ OPT. SLIDING DOOR
DOOR8

The Cedar | Plan G012 | First Floor Options
2,986 sq. ft. | 4 Bed | 2.5 Bath | 3 Car Garage | 2 Story

Any floorplan and/or elevation rendering is an artist's conceptual rendering intended to provide a general overview, but any such rendering does not constitute actual plans and specifications for any home. Renderings and pictures are representative and may depict floorplans, elevations, options, upgrades, landscaping, and other features and amenities that are not included as part of all homes and/or may not be available for all lots and/or in all communities. Renderings may not be drawn to scale. Any provided dimensions are approximate and actual dimensions may vary. Homes may be constructed with a floorplan that is the reverse of the floorplan rendering. Plans are copyrighted and/or otherwise subject to intellectual property rights of Meritage and/or others and cannot be reproduced or copied without Meritage's prior written consent. Plans and specifications, home features, and community information are subject to change, and homes to prior sale, at any time without notice or obligation. Additionally, deviations and variations may exist in any constructed home, including, without limitation: (i) substitution of materials and equipment of substantially equal or better quality; (ii) minor style, lot orientation, and color changes; (iii) minor variances in square footage and in room and space dimensions, and in window, door, utility outlet, and other improvement locations; (iv) changes as may be required by any state, federal, county, or local governmental authority in order to accommodate requested selections and/or options; and (v) value engineering and field changes.

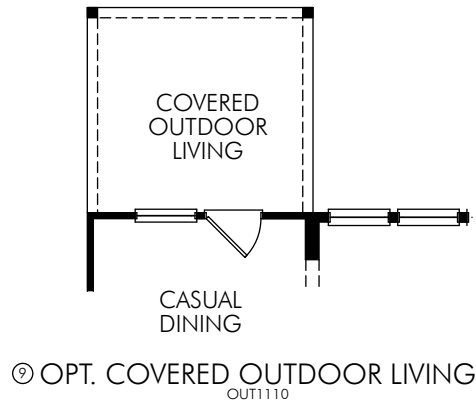
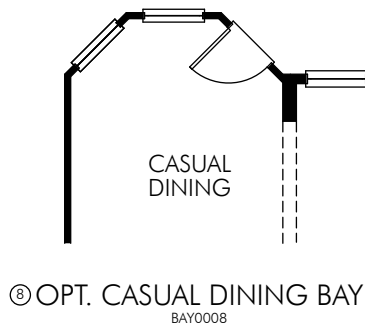
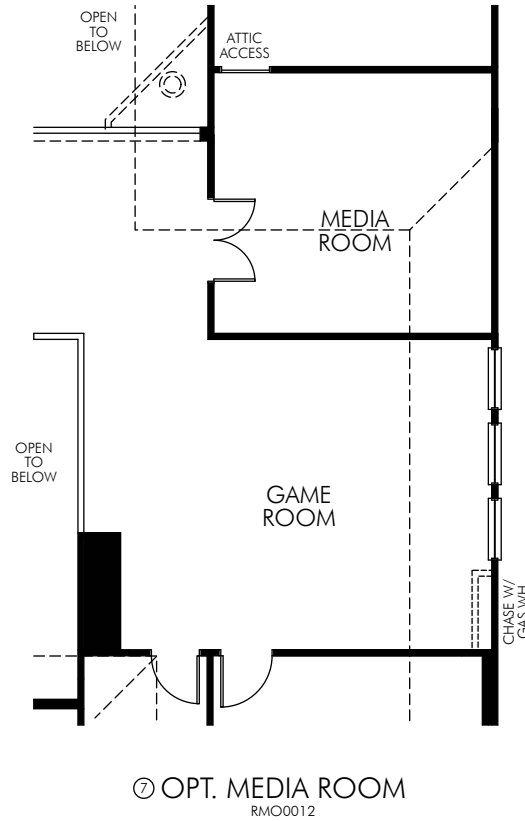
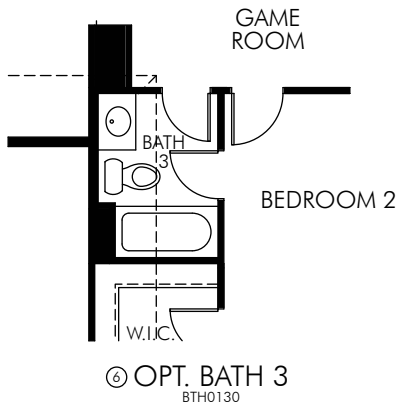

The Cedar | Plan G012 | First and Second Floor Options
2,986 sq. ft. | 4 Bed | 2.5 Bath | 3 Car Garage | 2 Story

Any floorplan and/or elevation rendering is an artist's conceptual rendering intended to provide a general overview, but any such rendering does not constitute actual plans and specifications for any home. Renderings and pictures are representative and may depict floorplans, elevations, options, upgrades, landscaping, and other features and amenities that are not included as part of all homes and/or may not be available for all lots and/or in all communities. Renderings may not be drawn to scale. Any provided dimensions are approximate and actual dimensions may vary. Homes may be constructed with a floorplan that is the reverse of the floorplan rendering. Plans are copyrighted and/or otherwise subject to intellectual property rights of Meritage and/or others and cannot be reproduced or copied without Meritage's prior written consent. Plans and specifications, home features, and community information are subject to change, and homes to prior sale, at any time without notice or obligation. Additionally, deviations and variations may exist in any constructed home, including, without limitation: (i) substitution of materials and equipment of substantially equal or better quality; (ii) minor style, lot orientation, and color changes; (iii) minor variances in square footage and in room and space dimensions, and in window, door, utility outlet, and other improvement locations; (iv) changes as may be required by any state, federal, county, or local governmental authority in order to accommodate requested selections and/or options; and (v) value engineering and field changes.