

The Cedar | Plan 4012 | First Floor
2,986 sq. ft. | 4 Bed | 2.5 Bath | 2 Car Garage | 2 Story

FLEX LIVING OPTIONS: Master Bay Window. Fireplace. Study. Gourmet Kitchen. Sliding Door. Casual Dining Bay Window. Covered Outdoor Living. Perfect Shower.

Rev 18-003
 REG 4012

Any floorplan and/or elevation rendering is an artist's conceptual rendering intended to provide a general overview, but any such rendering does not constitute actual plans and specifications for any home. Renderings and pictures are representative and may depict floorplans, elevations, options, upgrades, landscaping, and other features and amenities that are not included as part of all homes and/or may not be available for all lots and/or in all communities. Renderings may not be drawn to scale. Any provided dimensions are approximate and actual dimensions may vary. Homes may be constructed with a floorplan that is the reverse of the floorplan rendering. Plans are copyrighted and/or otherwise subject to intellectual property rights of Meritage and/or others and cannot be reproduced or copied without Meritage's prior written consent. Plans and specifications, home features, and community information are subject to change, and homes to prior sale, at any time without notice or obligation. Additionally, deviations and variations may exist in any constructed home, including, without limitation: (i) substitution of materials and equipment of substantially equal or better quality; (ii) minor style, lot orientation, and color changes; (iii) minor variances in square footage and in room and space dimensions, and in window, door, utility outlet, and other improvement locations; (iv) changes as may be required by any state, federal, county, or local governmental authority in order to accommodate requested selections and/or options; and (v) value engineering and field changes.

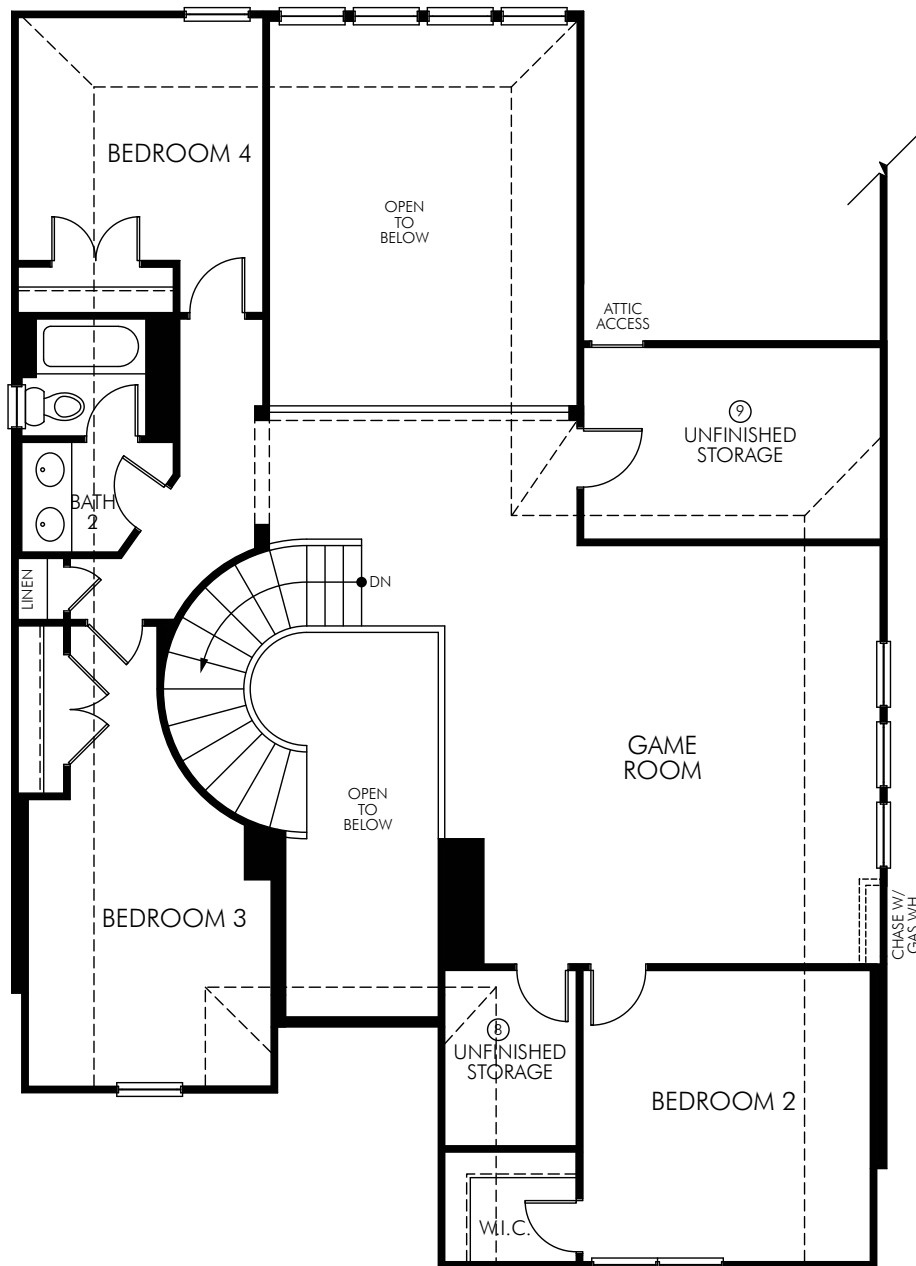

The Cedar | Plan 4012 | Second Floor
2,986 sq. ft. | 4 Bed | 2.5 Bath | 2 Car Garage | 2 Story

FLEX LIVING OPTIONS: Media Room. Bath 3.

Any floorplan and/or elevation rendering is an artist's conceptual rendering intended to provide a general overview, but any such rendering does not constitute actual plans and specifications for any home. Renderings and pictures are representative and may depict floorplans, elevations, options, upgrades, landscaping, and other features and amenities that are not included as part of all homes and/or may not be available for all lots and/or in all communities. Renderings may not be drawn to scale. Any provided dimensions are approximate and actual dimensions may vary. Homes may be constructed with a floorplan that is the reverse of the floorplan rendering. Plans are copyrighted and/or otherwise subject to intellectual property rights of Meritage and/or others and cannot be reproduced or copied without Meritage's prior written consent. Plans and specifications, home features, and community information are subject to change, and homes to prior sale, at any time without notice or obligation. Additionally, deviations and variations may exist in any constructed home, including, without limitation: (i) substitution of materials and equipment of substantially equal or better quality; (ii) minor style, lot orientation, and color changes; (iii) minor variances in square footage and in room and space dimensions, and in window, door, utility outlet, and other improvement locations; (iv) changes as may be required by any state, federal, county, or local governmental authority in order to accommodate requested selections and/or options; and (v) value engineering and field changes.

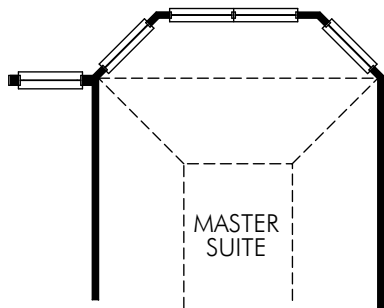

① OPT. MASTER BAY
-adding 40 sq. ft.
BAY0005

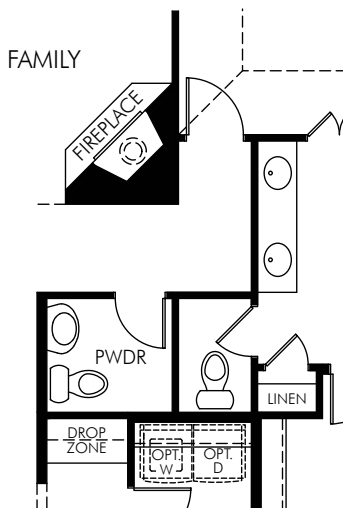

② OPT. FIREPLACE
FPO0108

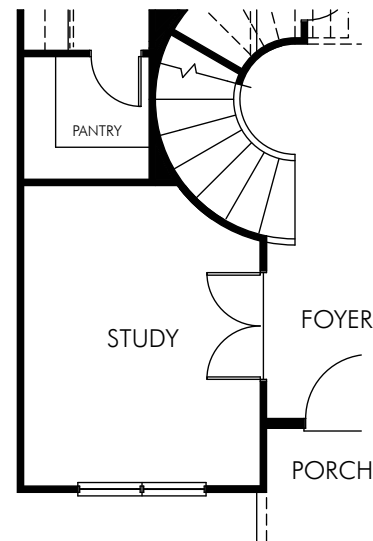

③ OPT. STUDY
RMO0015
WINDOW CONFIGURATIONS VARY BY ELEVATION

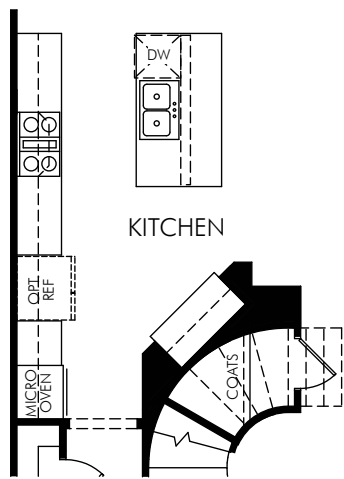

④ OPT. GOURMET KITCHEN
KIT1000

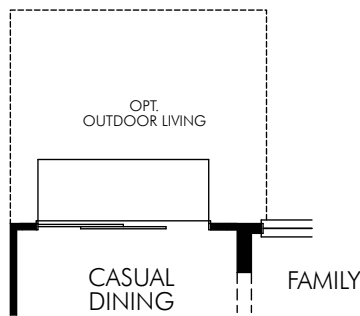

⑤ OPT. SLIDING DOOR
DOOR8

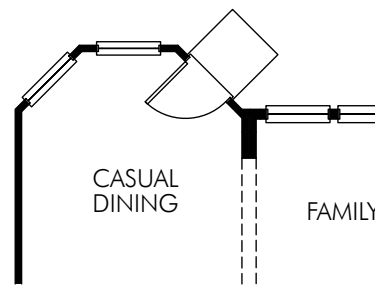

⑥ OPT. CASUAL DINING BAY WINDOW
-adding 30 sq. ft.
BAY0008

The Cedar | Plan 4012 | First Floor Options
2,986 sq. ft. | 4 Bed | 2.5 Bath | 2 Car Garage | 2 Story

Any floorplan and/or elevation rendering is an artist's conceptual rendering intended to provide a general overview, but any such rendering does not constitute actual plans and specifications for any home. Renderings and pictures are representative and may depict floorplans, elevations, options, upgrades, landscaping, and other features and amenities that are not included as part of all homes and/or may not be available for all lots and/or in all communities. Renderings may not be drawn to scale. Any provided dimensions are approximate and actual dimensions may vary. Homes may be constructed with a floorplan that is the reverse of the floorplan rendering. Plans are copyrighted and/or otherwise subject to intellectual property rights of Meritage and/or others and cannot be reproduced or copied without Meritage's prior written consent. Plans and specifications, home features, and community information are subject to change, and homes to prior sale, at any time without notice or obligation. Additionally, deviations and variations may exist in any constructed home, including, without limitation: (i) substitution of materials and equipment of substantially equal or better quality; (ii) minor style, lot orientation, and color changes; (iii) minor variances in square footage and in room and space dimensions, and in window, door, utility outlet, and other improvement locations; (iv) changes as may be required by any state, federal, county, or local governmental authority in order to accommodate requested selections and/or options; and (v) value engineering and field changes.

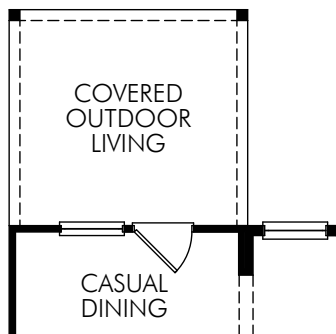

⑦ OPT. COVERED OUTDOOR LIVING
OUT1110

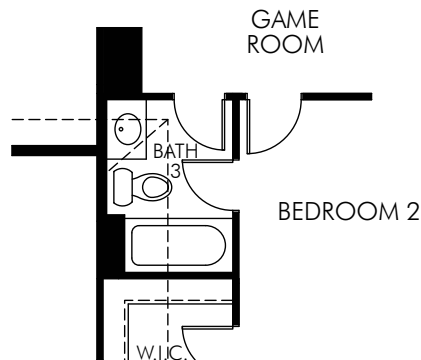

⑧ OPT. BATH 3
-adding 47 sq. ft.
BTH0130

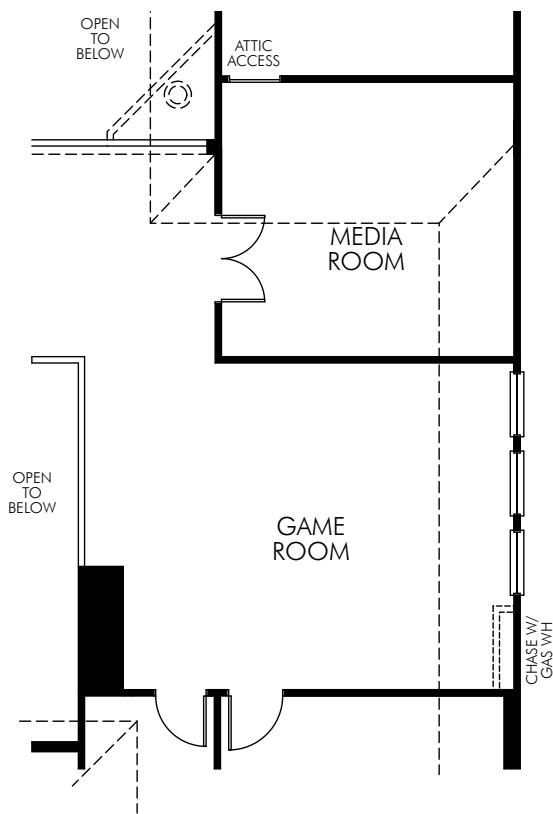

⑨ OPT. MEDIA ROOM
-adding 180 sq. ft.
RMO0012

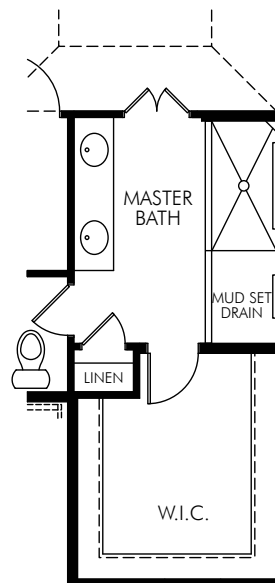

⑩ OPT. PERFECT SHOWER
PERFECT

The Cedar | Plan 4012 | First and Second Floor Options
2,986 sq. ft. | 4 Bed | 2.5 Bath | 2 Car Garage | 2 Story

Any floorplan and/or elevation rendering is an artist's conceptual rendering intended to provide a general overview, but any such rendering does not constitute actual plans and specifications for any home. Renderings and pictures are representative and may depict floorplans, elevations, options, upgrades, landscaping, and other features and amenities that are not included as part of all homes and/or may not be available for all lots and/or in all communities. Renderings may not be drawn to scale. Any provided dimensions are approximate and actual dimensions may vary. Homes may be constructed with a floorplan that is the reverse of the floorplan rendering. Plans are copyrighted and/or otherwise subject to intellectual property rights of Meritage and/or others and cannot be reproduced or copied without Meritage's prior written consent. Plans and specifications, home features, and community information are subject to change, and homes to prior sale, at any time without notice or obligation. Additionally, deviations and variations may exist in any constructed home, including, without limitation: (i) substitution of materials and equipment of substantially equal or better quality; (ii) minor style, lot orientation, and color changes; (iii) minor variances in square footage and in room and space dimensions, and in window, door, utility outlet, and other improvement locations; (iv) changes as may be required by any state, federal, county, or local governmental authority in order to accommodate requested selections and/or options; and (v) value engineering and field changes.